

ALUMINIUM CHANNELS - 1.5m; 2.1m; 2.4m; 3m; 3.6m; 6m; 7.2m (SCALE 1:1)

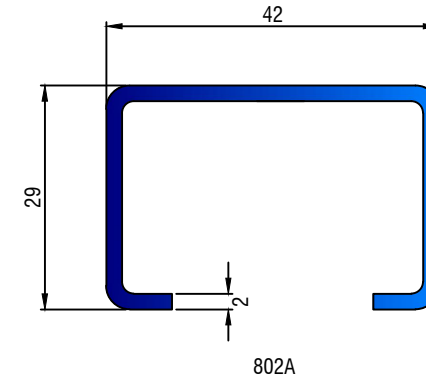

BRASS CHANNELS - 1.5m; 2.1m; 2.4m; 3m; 3.6m; 6m; 7.2m (SCALE 1:1)

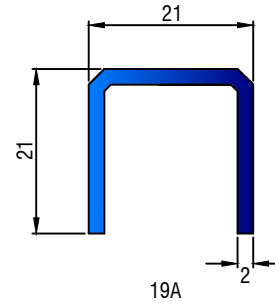
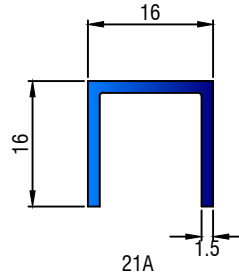
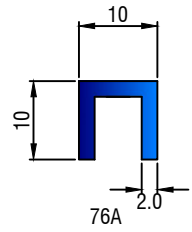
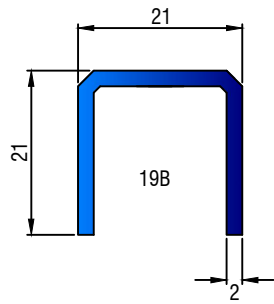

STEEL CHANNELS - 1.5m; 2.1m; 2.4m; 3m; 3.6m; 6m; 7.2m (SCALE 1:1)

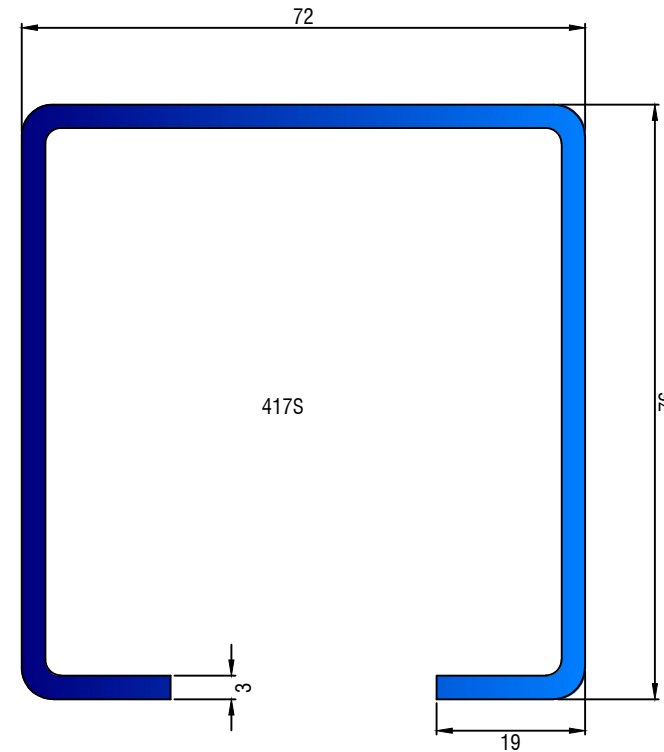
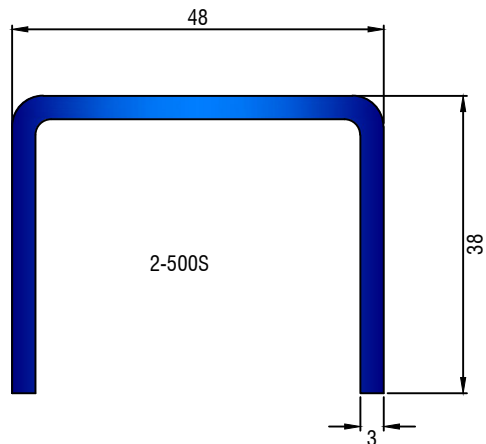

Hillaldam Coburn Systems (Pty) Ltd.
 P O Box 4664, Johannesburg 2000,
 South Africa
 Tel: (+2711) 626 1001
 Fax: (+2711) 626 1341
 Email: info@hillaldam.co.za
 Web: www.hillaldam.net